

## ON-BOARD

SPLIT  
VERSION

COMPACT  
VERSION

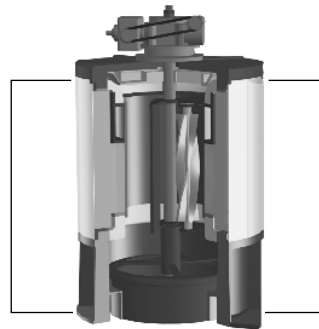

<-9°C / <16°F



Ice thickness  
1,8-2,2 mm



Scale Ice  
Makers Units

Unité de  
Production  
de Glace  
en Ecailles

Scherbeneis  
Produktions-  
einheit

Fabricador  
de Hielo  
en Escamas

Unità di  
Produzione  
Ghiaccio  
in scaglie

Fresh Water	NaCl Sea Water	24h		24h		[v/Hz/ph]	[WxDxH mm]	[xHWxD inches]	R404a or R22
		Ambient T. +25°C (77°F) Water T. +15°C (59°F)	[kg]	[lbs]	Ambient T. +32°C (90°F) Water T. +21°C (70°F)				
EVE 200 WS	EVE 200 WS SW	1.900	4.188	1.600	3.530	400/50Hz/3ph 230/60Hz/3ph	2150x1900x1360	84 5/8" x 74 3/4" x 53 1/2"	R404a or R22
EVE 300 WS	EVE 300 WS SW	2.900	6.392	2.300	5.070	400/50Hz/3ph 230/60Hz/3ph	2150x1900x1360	84 5/8" x 74 3/4" x 53 1/2"	R404a or R22
EVE 400 WS	EVE 400 WS SW	3.900	8.596	3.500	7.720	400/50Hz/3ph 230/60Hz/3ph	2150x1900x1750	84 5/8" x 74 3/4" x 68 7/8"	R404a or R22
EVE 650 WS	EVE 650 WS SW	6.200	13.665	5.800	12.790	400/50Hz/3ph 230/60Hz/3ph	2850x2250x1750	112 1/4" x 88 5/8" x 68 7/8"	R404a or R22
EVE 800 WS	EVE 800 WS SW	7.650	16.861	7.500	16.530	400/50Hz/3ph 230/60Hz/3ph	3450x1990x2020	135 7/8" x 78 3/8" x 79 1/2"	R404a or R22
EVE 1000 WS	EVE 1000 WS SW	9.800	21.599	9.000	19.840	400/50Hz/3ph 230/60Hz/3ph	4350x2310x2100	171 1/4" x 91" x 82 5/8"	R404a/R22/R717
EVE 1300 WS	EVE 1300 WS SW	12.500	27.550	11.000	24.250	400/50Hz/3ph 230/60Hz/3ph	4850x2310x2400	191" x 91" x 94 1/2"	R404a/R22/R717
EVE 1500 WS	EVE 1500 WS SW	15.000	33.060	13.500	29.760	400/50Hz/3ph 230/60Hz/3ph	4850x2310x2400	191" x 91" x 94 1/2"	R404a/R22/R717

# 1

Years Warranty  
Ans de Garantie  
Jahre Garantie  
Años de Garantía  
Anni di Garanzia

Subject to certain limitations and exclusions  
Assujettie aux limites et exclusions prescrites  
Abhängig von Bestimmten Einschränkungen und Ausnahmen  
Sujeta a algunas limitaciones y exclusiones  
Soggetta ad alcune limitazioni ed esclusioni



This product qualifies for the following listings:



EVE200/300/400/650

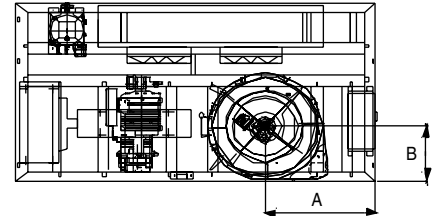
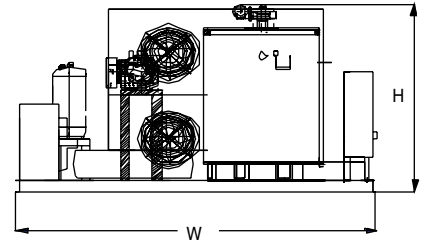
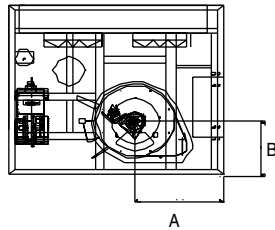
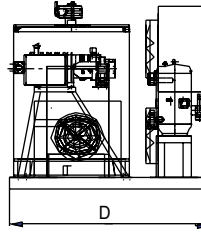
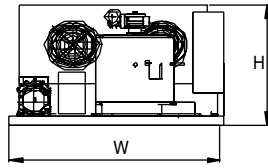
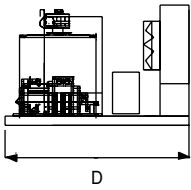

Fresh Water	Sea Water	Nominal Electrical Power KW	W mm	D mm	H mm	A mm	B mm	Ice Outlet (ø mm)	Inlet Water	Overflow (mm)	[kg]	[lbs]	[kg] [lbs]
EVE 200 WS	EVE 200 WS SW	12,00	1900	1650	1160	750	435	420	1/2"	10	780	1719	t.b.a.
EVE 300 WS	EVE 300 WS SW	16,00	1900	1650	1160	750	435	420	1/2"	10	800	1763	t.b.a.
EVE 400 WS	EVE 400 WS SW	20,00	1900	1650	1550	750	435	420	1/2"	10	1.150	2535	t.b.a.
EVE 650 WS	EVE 650 WS SW	35,00	2600	2000	1550	1035	545	670	1/2"	10	2.000	4408	t.b.a.
EVE 800 WS	EVE 800 WS SW	35,00 (*)	3200	1740	1820	990	535	670	1/2"	10	2.220	4849	t.b.a.
EVE 1000 WS	EVE 1000 WS SW	40,00 (*)	4100	2060	1900	1265	545	840	3/4"	10	2.950	6502	t.b.a.
EVE 1300 WS	EVE 1300 WS SW	55,00 (*)	4600	2060	2200	1135	545	840	3/4"	10	3.750	8265	t.b.a.
EVE 1500 WS	EVE 1500 WS SW	70,00 (*)	4600	2060	2200	1135	545	840	3/4"	10	4.300	9477	t.b.a.

\*Screw compressor

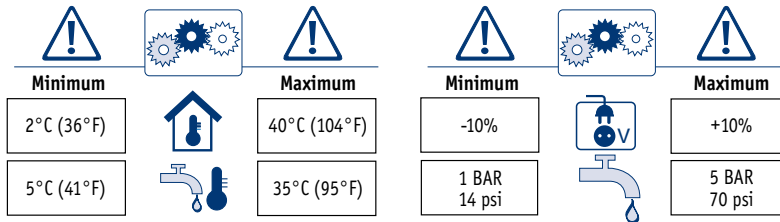

Features: heavy basement frame in HIB iron, galvanized; AISI 304 Stainless steel evaporator complete of expansion valve /refrigerant level control (R404a/R22); base and cover in Peralluman; dosing water pump; dripping-pan; gear-motor with system for ice-scraper rotation; semi-hermetic /screw compressor; Liquid receiver and oil separator; Filters for suction and liquid lines; oil filters for version 1000/1500; Copper piping with valves on main components in order to ease maintenance; Water cooled condenser (SW sea water); Automatic electrical control panel complete of main switch, power and auxiliary contactors, voltmeter and ammeter, pressure switch (refrigerant high/low/ oil), fan protections, ice-scraper protection, pump-down control. All versions are certified CE/PED.

Caractéristiques techniques: Structure portante HIB en acier galvanize ; évaporateur en acier inox AISI 304 complet de détendeur /contrôle de niveau (R404a/R22); basement et couvercle en Peralluman; pompe dosage eau/sel; bassin écoulement eau; moteur qui entraine fraise hélicoïdale acier inox; compresseur semi-hermetique/vis; récepteur de liquide et séparateur d'huile; filtres sur tuyaux aspiration et liquide; filtre huile pour modèles 1000/1500; tuyauterie en cuivre avec vanne sur les principaux composants pour simplifier l'entretien; condensateur eau (SW eau de mer); tableau électrique complet de interrupteur général, contacteurs puissance et auxiliaires, voltmètre et ampèremètre, pressostats (réfrigérant haute, basse et huile), protections ventilateurs et fraise, pump-down control. Tous les modèles sont certifiés CE/PED.

Technische Beschreibung: Trägerhäuse HIP aus verzinktem Stahl. Verdampfer aus AISI 304 Edelstahl komplett mit Expansionsventil und Kältemittelfüllstandsanzeige (R404a/R22). Rahmen und Abdeckung aus Peralluman. Dosierpumpe für Salz/Wasser. Auffangschale. Getriebe-motor mit Eisbrechereinheit. Halbhermetischer Verdichter oder Schraubenverdichter. Kältemittelsammler und Ölabscheider. Trockner in Saug- und Flüssigkeitsleitung. Ölfilter für die 1000/1500 Modelle. Absperrventile in den Kupferrohrleitungen für die leichte Wartung. Süßwasser Verflüssiger (WS) oder für Salzwasser (SW). Elektromechanische Anzeige mit Hauptschalter, Leistungs- und Hilfsschutz mit Spannungs und Amperenanzeige, Druckschalter für (Hoch/Nieder/ Öl). Schutzvorrichtung für Lüfter und Eisbrecher, Pump-down Schaltung. Alle Modelle sind zertifiziert mit CE/PED.

Características técnicas: Estructura portante HIB de acero galvanizado; evaporador de acero AISI 304 compuesto de válvula termostática/control de nivel (R404a/R22); base y tapa de Peralluman; bomba alimentación agua/sal; bandeja desagüe; motor rotación rompe-hielo de acero inox; compresor semihermético/tornillo; reserva de líquido y separador aceite; filtros en tubería aspiración y líquido; filtro aceite para modelos 1000/1500; tubería en cobre con válvulas de parcialización en todos los componentes principales para simplificar el mantenimiento; condensador agua (SW agua de mar); cuadro eléctrico compuesto de interruptor general, contactores potencia y auxiliares, voltmetro y ampermetro, presostatos (refrigerante alta, baja y aceite), protecciones ventiladores y rompe-hielo, control pump-down. Todos los modelos están certificados CE/PED.

Caratteristiche tecniche: Struttura portante HIP in acciaio zincato; evaporatore in acciaio inox AISI 304 completo di valvola termostatica/regolatore di livello (R404a/R22); base e coperchio in Peralluman; pompa dosatrice acqua/sale; ghiotta raccogli condensa; motoriduttore per rotazione rompihaccio in acciaio inox; compressore semi-hermetico/vite; ricevitore di liquido e separatore d'olio; filtri su mandata e aspirazione; filtro olio per modelli 1000/1500; tubazioni in rame con rubinetti di parzializzazione sui principali componenti per facilitare la manutenzione; condensatore ad acqua (SW acqua di mare); quadro elettrico completo di interruttore generale, contattore di potenza e ausiliari, voltmetro e amperometro, pressostati (refrigerante alta, bassa e olio), protezioni ventilatori e rompihaccio, controllo pump-down. Tutte le macchine sono certificate CE/PED.

**Scotsman**® The one the world relies on.  
Ice Systems

Certified ISO 9001:2000

<p><b>USA, Canada, Latin America</b> Scotsman Ice Systems USA 775 Corporate Woods Parkway Vernon Hills, IL 60061 Ph: (+1) 847 215-4550 Fax (+1) 847 913-9844 customer.service@scotsman-ice.com</p>	<p><b>Europe</b> Scotsman Europe-Frimont S.p.A. Via Puccini, 22 20010 Pogliano (Milano) Italy Ph: (+39) 02-93960208 Fax: (+39) 02-93960201 scotsman.europe@frimont.it</p>	<p><b>Asia and Pacific</b> Scotsman Ice Systems-Frimont S.p.A. (R.O.) 627A Aljunied Road #04-04 Biztech Centre Singapore 389842 Ph: (+65) 6738 5393 Fax: (+65) 6738 1959 scotsice@singnet.com.sg</p>	<p><b>China</b> Scotsman Ice Systems (Shanghai) Co., Ltd Room 405-407 Jing'an China Tower 1701 West Beijing Road-200040 Shanghai Ph: (+86) 21-62476056-Fax: (+86) 21-62476126 scotsmansh@online.sh.cn</p>	<p><b>Middle East &amp; N. Africa</b> Scotsman Ice Systems Dubai Office P.o. Box 21648 Sharjah - U.A.E. Mobile: Ph: (+971) 505505980 Fax (+971) 6-5654063 scotsman@eim.ae</p>	<p><b>ICE SYSTEMS</b> (Pty) Ltd 21 Atlas rd, Dunswart, Boksburg P.O. Box 6766, Dunswart, 1058 Tel: (+27) 11-9185065 Fax: (+27) 11-9185068 www.icesystems.co.za</p>
--	---	--	---	---	--